

STAR WARS

METAL EARTH[™]

3D METAL MODEL KITS

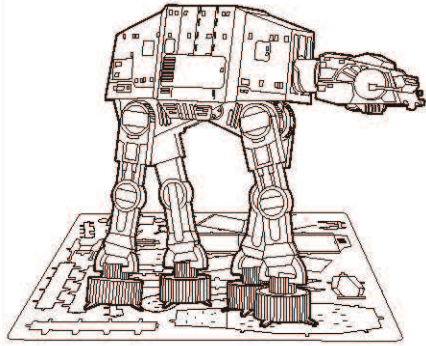

AT-AT[™]

360°
view



It is highly recommended that you visit www.fascinations.com/metalearth360/mms252 to see the completed model before assembling your own. Vor dem Zusammenbau Ihres Modells besuchen Sie bitte <http://www.fascinations.com/metalearth/gallery360> für die Ansicht des aufgebauten Modells.

To create the best connections Beste Verbindungen

● Insert tab and bend 90 degrees for most visible areas
Laschen einfügen und 90° umbiegen (bei den meisten sichtbaren Flächen).

▲ Insert tab and twist 90 degrees is best in some areas to ensure a tight connection
Laschen einfügen und um 90° verdrehen (in einigen Bereichen für eine straffe Verbindung sinnvoll).

Needle nose pliers are helpful for assembly
Notwendiges Werkzeug: Spitzzange.

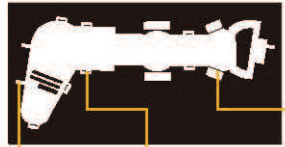
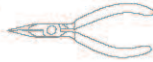
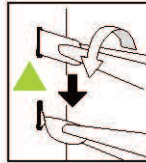
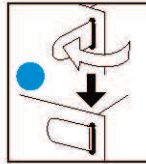

Insertion tabs are inserted and then folded
Verbindungspunkt Laschen einstecken und umbiegen bzw. verdrehen.

Insertion holes
Einsteckschlitze

Fold lines can be seen as shown here
Falzlinie (beispielhafte Darstellung).

Metal Sheets Metallbogen

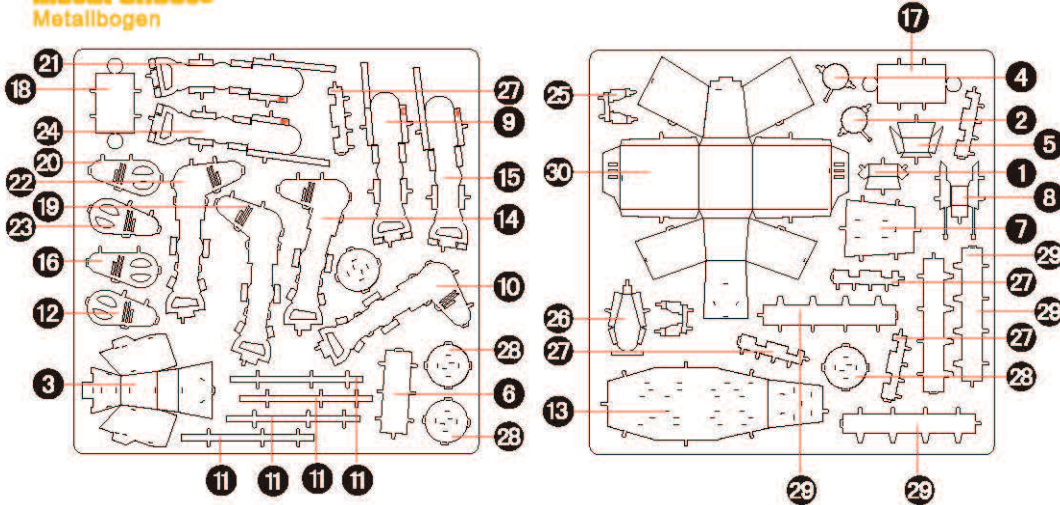

Notes:

In order to avoid possible injury from sharp edges, please carefully discard the metal sheet after parts have been removed.

Nach dem Herauslösen aller Bauteile den Rest des Metallbogens sicher entsorgen, um Verletzungen an scharfen Kanten zu vermeiden.

This product is not a toy. Keep out of reach of children.

Sammlermodell - kein Kinderspielzeug. Von Kindern unter 14 Jahren fernhalten. Alter: 14+

Assembly Flow Chart Ablaufschema für den Aufbau des Modells:

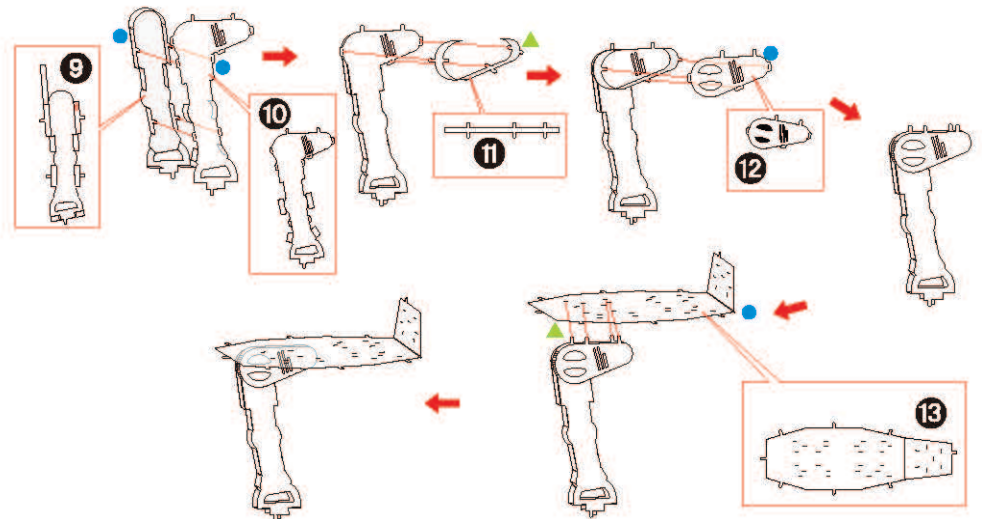
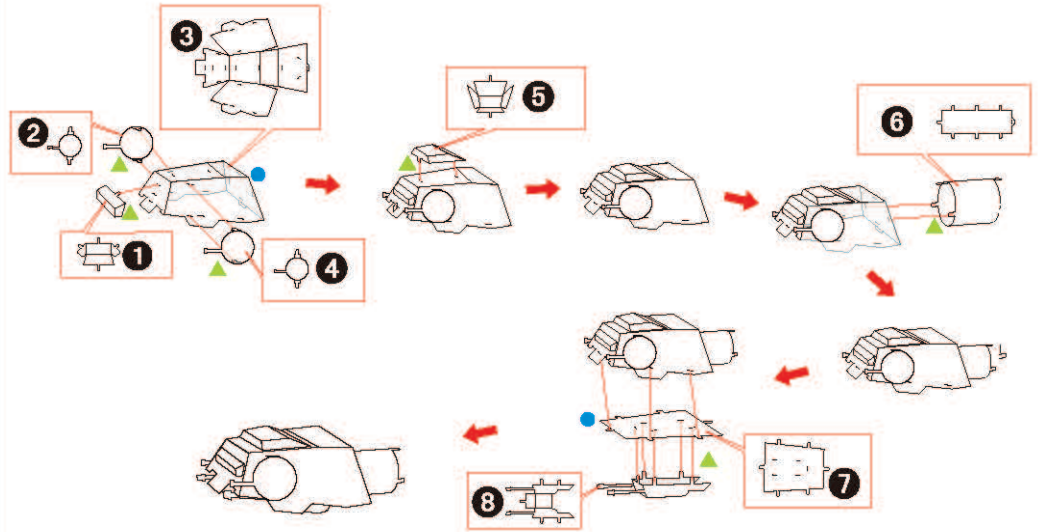

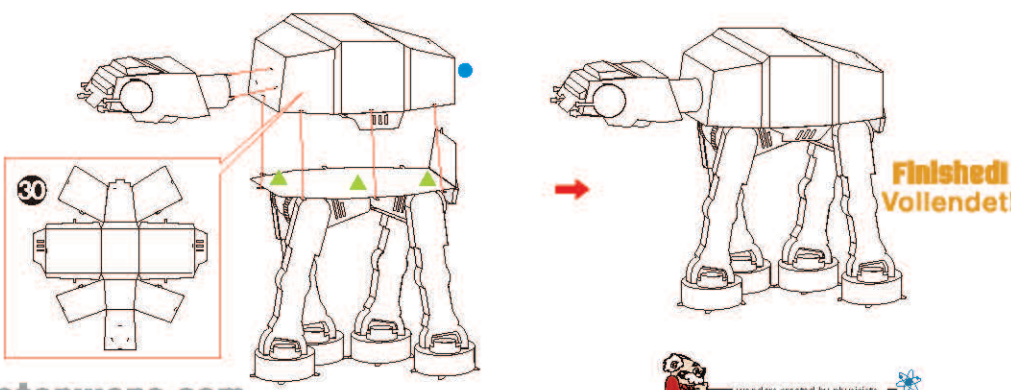
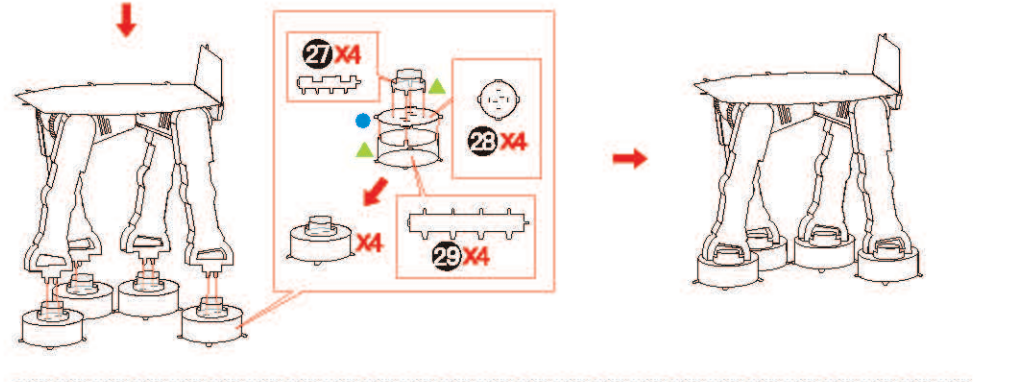
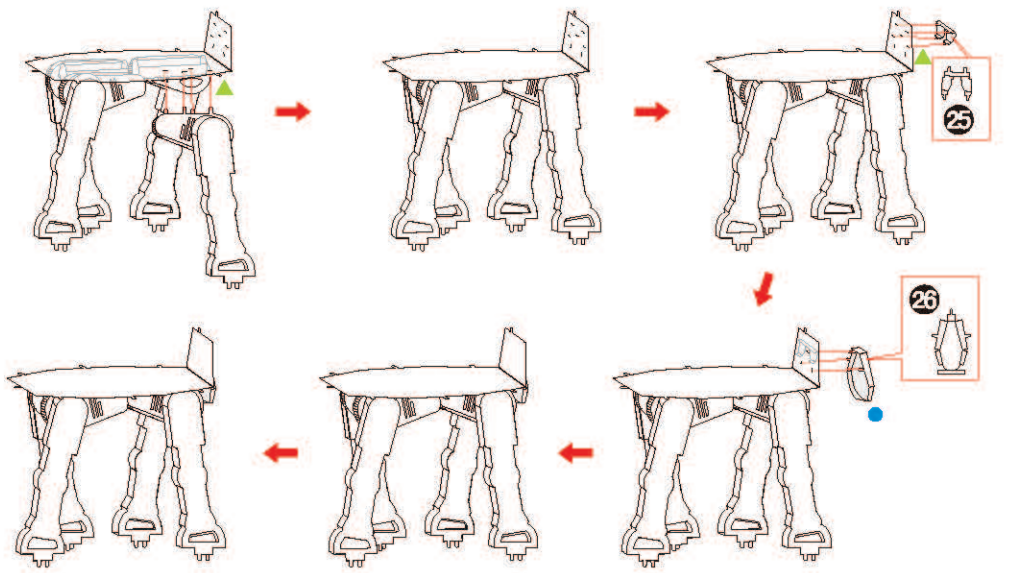
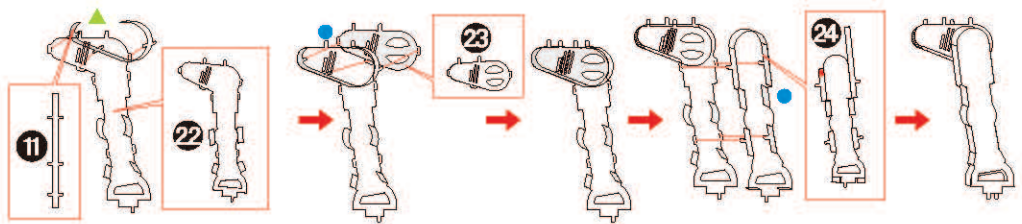
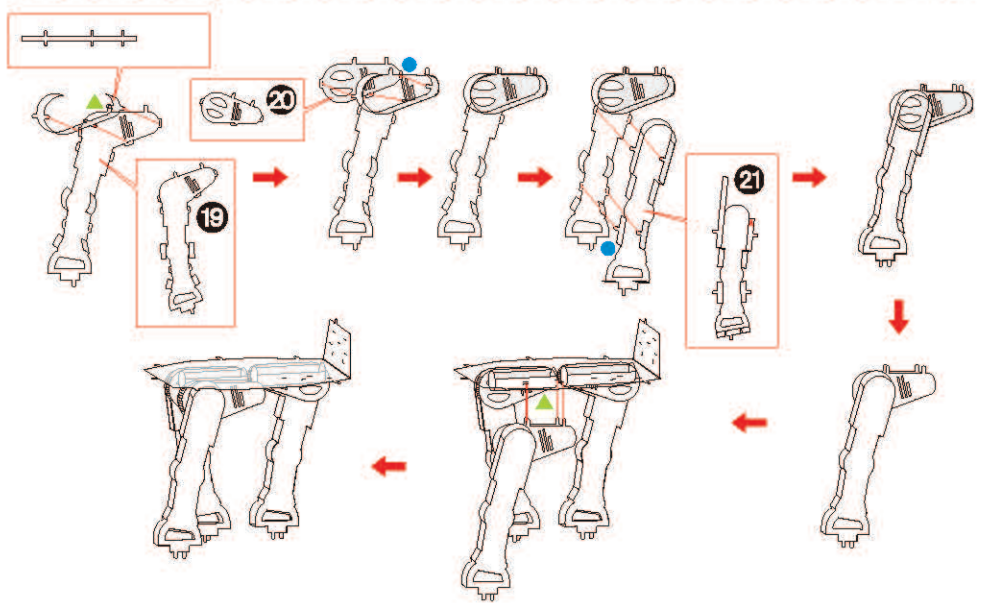
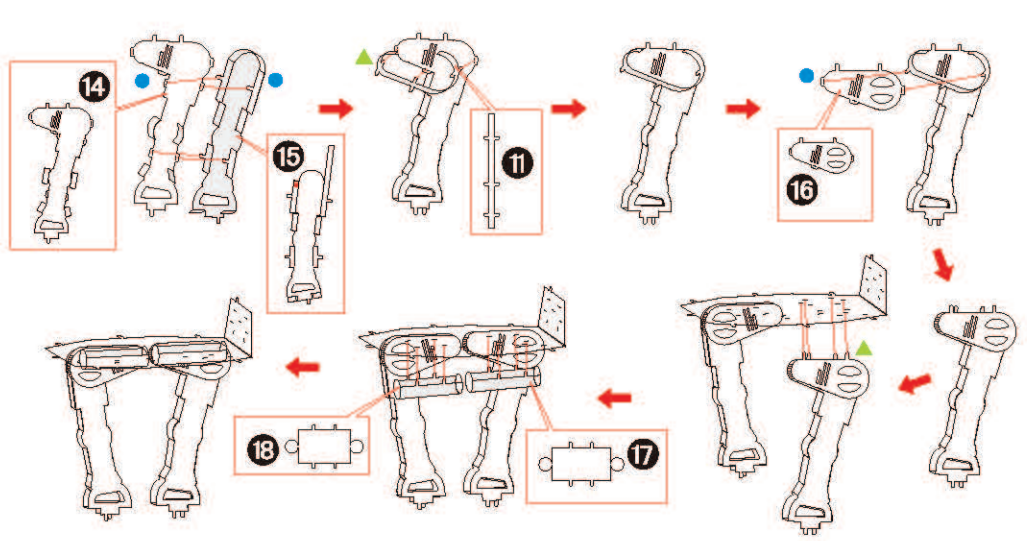

Finished!
Vollendet!